

BioPrism® Solid Surface

Installation Instructions Large Corner Shower Caddy

Please read all instructions before installing products.

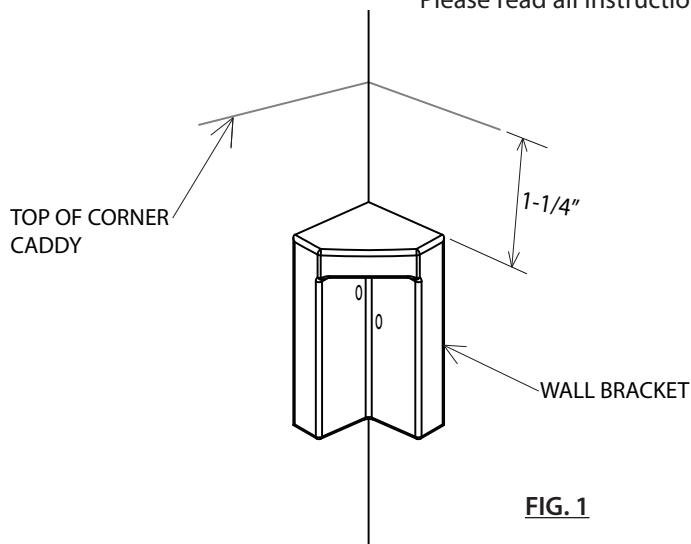

FIG. 1

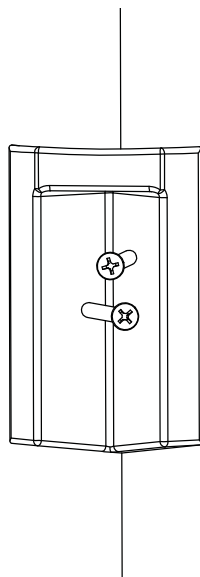

FIG. 2

1. Make sure all surfaces are clean and free of dust, dirt, grease, and soap scum.

2. Hold the Shower Caddy in the corner of the shower or tub surround. Determine the height and placement of the Corner Caddy and mark the location on the wall.

3. From height placement, measure down 1-1/4" for placement of the mounting bracket. *See Figure 1.*

4. Drill 1/4" Pilot hole through the mounting bracket and wall material into the corner studs.

5. Using 2 - 3" long screws, mount the bracket to the wall. Do not over tighten the screws, too much pressure could crack the wall substrate behind the bracket. *See Figures 2 and 3.*

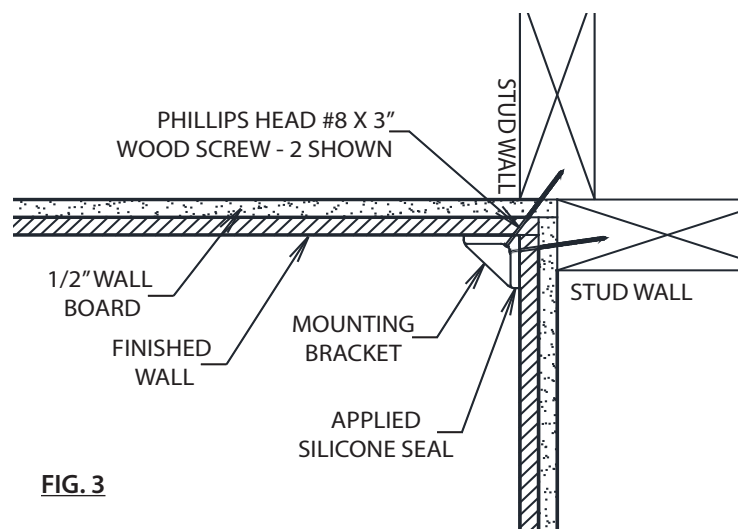

FIG. 3

IPC.1761/REV.1

BioPrism® Solid Surface Installation Instructions Large Corner Shower Caddy

SILICONE
ADHESIVE

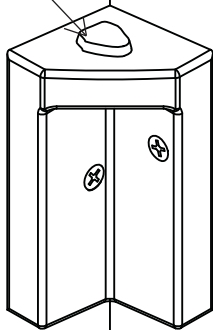
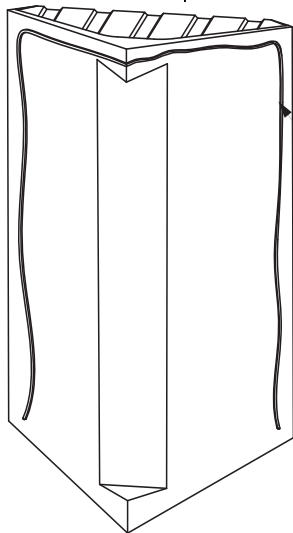

FIG. 4

6. Apply quarter sized dab of silicone adhesive to the top of the mounting bracket. *See Figure 4.* Apply silicone as shown to the back side of the caddy. *See Figure 5.*



SILICONE
ADHESIVE ON
BACK OF CADDY

FIG. 5

7. Hang the caddy on the mounting bracket. Gently push down on the caddy to seat it on the bracket. Press the caddy into the corner to seat the adhesive, on the back of the caddy, on to the walls. *See Figure 6.*

8. Seal around the entire perimeter of the caddy with silicone. Clean up excess silicone with denatured alcohol. *See Figure 7.*

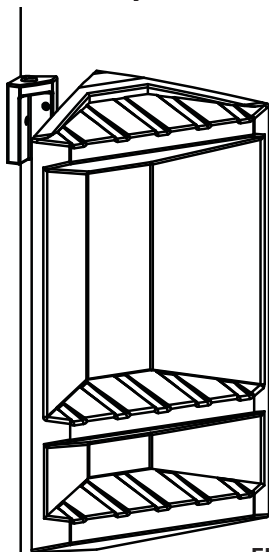
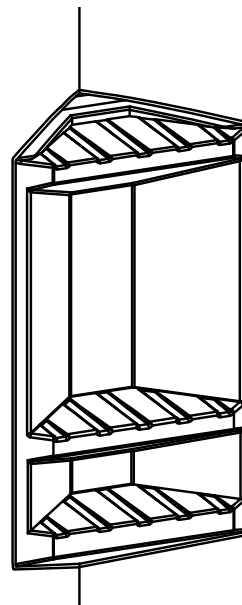

FIG. 6



SILICONE

FIG. 7

Installation Hotline • 866.EZINPRO

Inprocorp.com • 800.222.5556 • 262.679.9010

World Headquarters S80 W18766 Apollo Drive, Muskego, WI 53150 USA

ENDURANT®
WASHROOM SYSTEMS